



YOUR MUSIC. **YOUR POWER.**

The 35000.1 EVOX is designed exclusively for competitions and should not be installed on systems for daily use.

OWNER'S MANUAL
35000.1 EVOX

EVOX

Introduction	3
Package contents	3
Safety instructions	4
Technologies	
Vibration Absorption System	5
I-Power Supply	5
Low Bass Correction	6
Assembling and Disassembling the plastic cover	7
Panels description	
Audio inputs, outputs and controls	8
Power inputs	9
Electrical Dimensioning	10
Audio input and output	10
Installation sequence	11
SD RLC and Gain adjustment procedure	12
Bass Boost set up	13
Crossovers set up	13
Wiring Diagram	14
Battery connection diagram	15
Technical specs	
Parameters	16
Dimensional data	16
Additional Information	16

DEAR CUSTOMER,**CONGRATULATIONS ON ACQUIRING A PRODUCT WITH THE HIGHEST QUALITY AND TECHNOLOGY!**

You have just purchased a *SounDigital* product of the highest technology and quality, so we thank you for your confidence.

Class D Amplifiers:

Class D amplifiers have as main characteristics the audio quality, efficiency, application versatility and compact design. Following are the advantages of these features:

Audio Quality – In the past, Class D products had limited response and for higher frequencies, Class AB products performed better, but their efficiency was very low. The new technologies introduced by SounDigital resulted in a Class D amplifier with high efficiency and superior Class AB performance.

Efficiency – SounDigital Class D amplifiers have total efficiency (output + power source) greater than 70%, which guarantees lower battery consumption and less heating.

Application Versatility – The flat full-frequency response of SounDigital amplifiers allows them to be used in all car sound systems. Meeting the demands with extreme quality.

Compact Design – The high efficiency and high technology applied, allows SounDigital amplifiers to be very compact, facilitating installation in vehicles where space is limited.

IMPORTANT INFORMATIONS

On this manual you will learn about the product, its features and characteristics, in order to obtain the best result and to be able to enjoy your music with *SounDigital* quality and power.

To better understand and take advantage of all the functions of the product and use it safely, read this manual carefully and if you have any questions, consult our support by email: **info@soundigitalusa.com**.

PACKAGE CONTENTS

- 01 **35000.1 EVOX** Amplifier
- 01 Installation quick guide with warranty card
- 01 Allen wrench 2.5mm
- 01 Allen wrench 3.0mm
- 01 Allen wrench 4.0mm
- 01 Promotional sticker

**Warning!**







THE 35000.1 EVOX IS DESIGNED EXCLUSIVELY FOR SPL COMPETITIONS AND SHOULD NOT BE INSTALLED ON SYSTEMS FOR DAILY USE.

TO AVOID INJURY TO THE USER OR DAMAGE TO THE AMPLIFIER, READ ALL SAFETY INSTRUCTIONS WRITTEN ON THIS MANUAL.

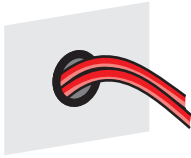
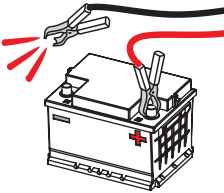
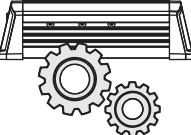

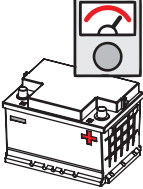
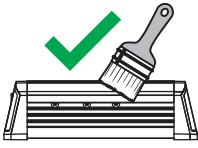
Warning!

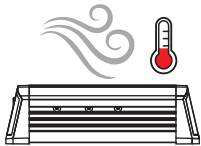
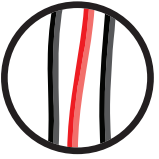
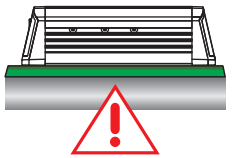
THIS "WARNING" SIGN ALERTS THE USER OF IMPORTANT INFO. NOT FOLLOWING THIS INSTRUCTIONS MAY CAUSE INJURIES TO THE USER OR DAMAGE TO THE EQUIPMENT.

<p>The installation of this product must be done by a qualified professional. In case of any doubt, please contact our technical support;</p>		 <p>When passing cables through metallic walls, use rubber O-rings to avoid cable cutting and short-circuits;</p>
<p>Before proceeding with the installation of any electric equipment on your vehicle, unplug the negative (-) terminal of the battery to avoid fires, injuries or damages;</p>		 <p>Make sure that the chosen location for the amplifier installation does not affect the operation of the vehicle;</p>
<p>Use your sound system safely. The continuous exposure to sound pressures over 85dB may cause irreversible hearing damage;</p>		 <p>This product may reach temperatures over 60°C (140°F). Make sure it is cold before touching it;</p>
<p>This equipment must be supplied with +12VDC to +18VDC. Before installing the equipment, check voltage of the batteries;</p>		 <p>Clean the amplifier periodically with brush or dry cloth to assure the thermal efficiency of the heatsink;</p>
<p>Do not install the amplifier in places exposed to water, dirt or humidity;</p>		 <p>Be careful when making holes in the vehicle. Make sure you are not making holes in the fuel tank, brake lines or electrical cables of the vehicle;</p>
<p>Choose a ventilated place to install the amplifier and avoid blocking the side ventilation windows;</p>		 <p>Make sure the cables are properly secured throughout the installation;</p>
<p>Fix the amplifier properly and firmly. Avoid fixing to metallic parts of the vehicle, as this procedure may cause ground looping (noise);</p>		 <p>Wear gloves, safety glasses and all necessary PPE during the installation of Soundigital amplifiers.</p>



Warning!

THE 35000.1EVOX MUST BE SUPPLIED WITH +12VDC TO +18VDC ONLY WHEN PARTICIPATING ON THE COMPETITIONS. AFTER THE MEASUREMENTS, THE FUSES OR CIRCUIT BREAKERS MUST BE SWITCHED OFF.

VIBRATION ABSORPTION SYSTEM - VAS®

Our VAS® Technology reduces all impact caused by vibration on the electronic circuit board. This can include road vibration and even vibration caused by sound waves, increasing the reliability of our amplifiers.

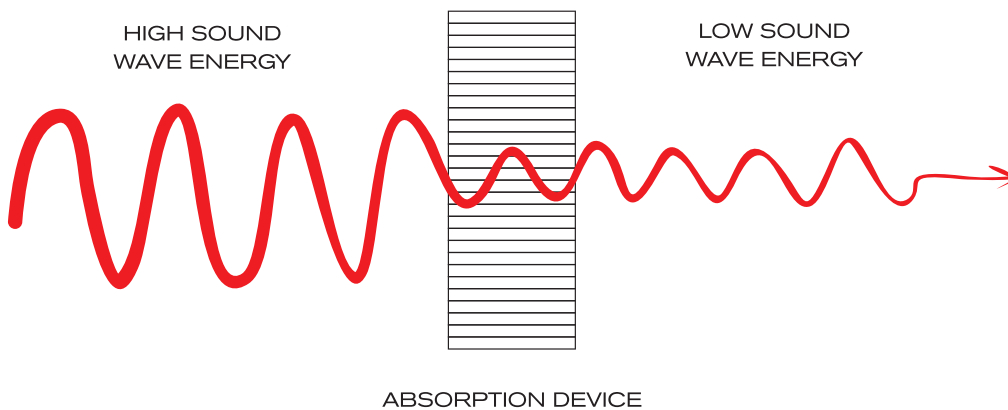

I-POWER SUPPLY

SounDigital amplifiers are known for their low consumption of battery, and this feature was improved on the **EVOX Line**. The new **I-POWER SUPPLY** is even more modern, which replaces the old toroidal transformers by a new generation of "E-E" core transformers delivers efficiency above 90%*, ensuring more hours of sound without battery recharge.

**Efficiency measured at power supply only.*



ULTRA COMPACT PCB

An intelligent layout, with great use of the PCB area and the use of modern components with reduced structure guarantee **SounDigital** products a compact design, at the same time robust and with excellent thermal efficiency.

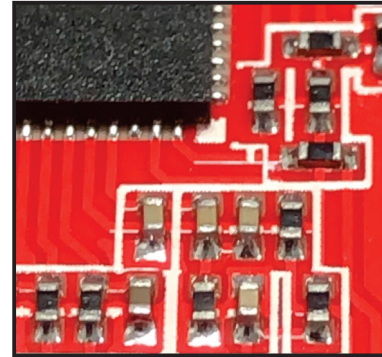

REDUCED SIZE

The technology used in our amplifiers bring both high performance and power a compact chassis, providing flexible installation solutions for vehicles with limited space.

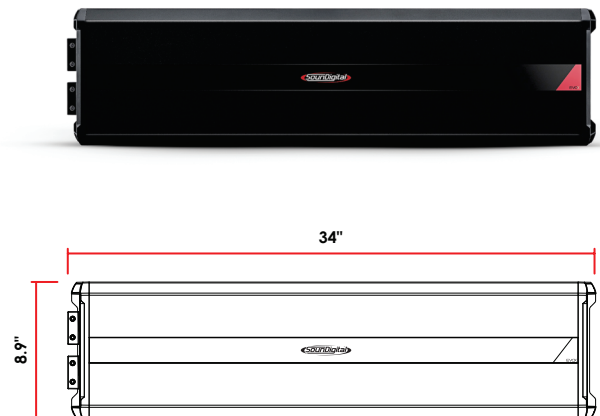

LOW BASS CORRECTION

The design of the EVOX line of amplifiers aims to give users the feeling of the smooth and deep bass, without compromise! Our Low Bass Correction technology compares the input signals to the amplifier against the output after the amplification stage, making real time correction of the signal, delivering a deeper bass with less distortion.



*Merely illustrative image.

The plastic covers are used to finish off and hide the amplifier's fixing screws. To disassemble and assemble them, follow the instructions below.

DISASSEMBLING OF THE PLASTIC COVER

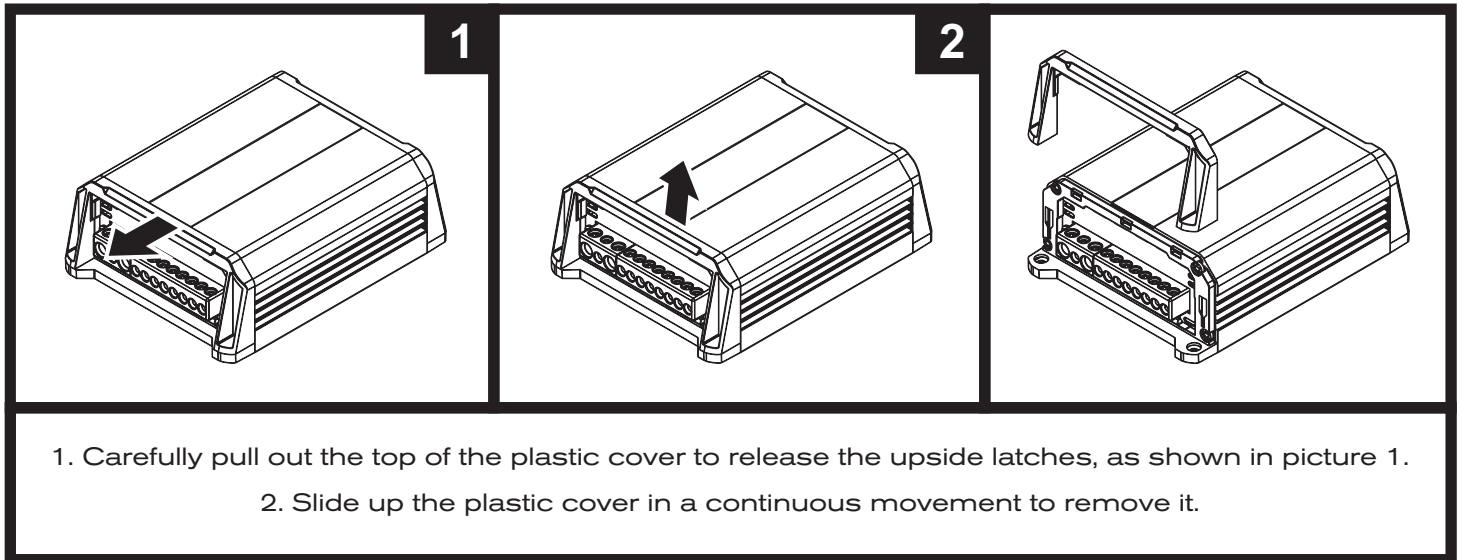

*Merely illustrative images.

ASSEMBLING THE PLASTIC COVER

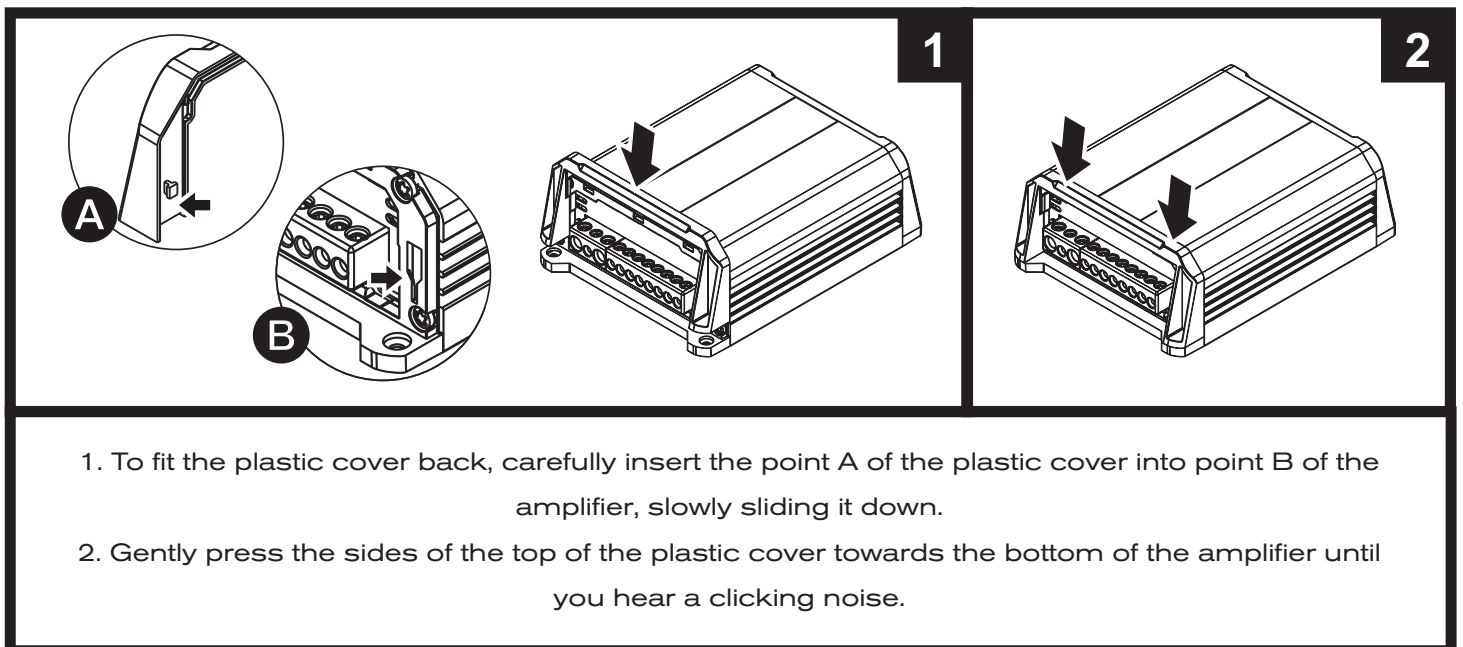

*Merely illustrative images.

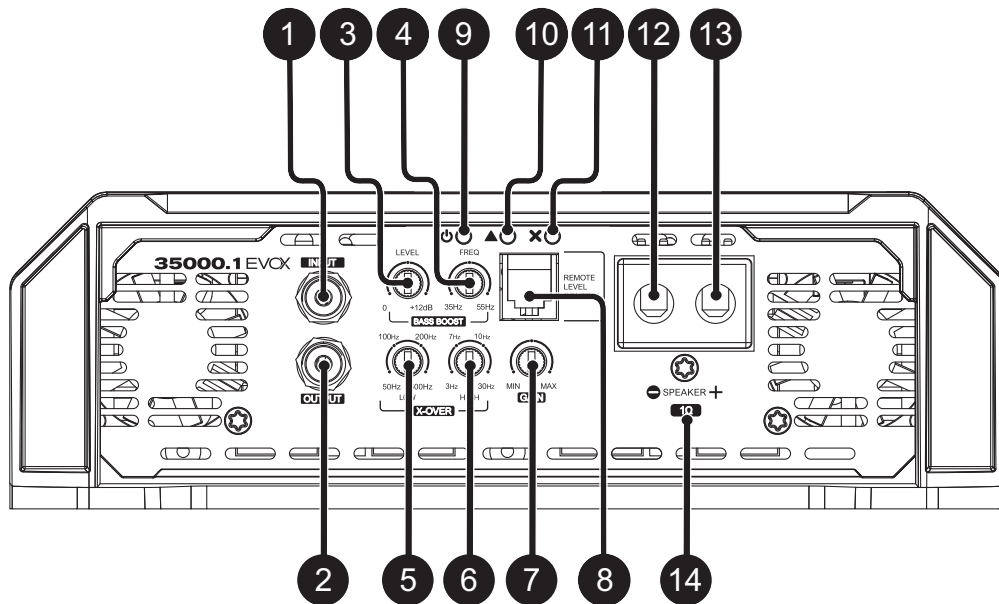

1	Audio input	RCA Connectors
2	Audio output	
3	-	Variable Bass Boost Level Control (0dB ~ +12dB)
4	-	Variable Bass Boost Frequency Control (35Hz ~ 55Hz)
5	-	Variable Low Pass filter control (50Hz ~ 500Hz)
6	-	Variable High Pass filter control (3Hz ~ 30Hz)
7	-	Variable Gain control
8	-	Remote level control connector
9	Blue	"POWER ON" LED indicator
10	Yellow	"CLIP" LED indicator
11	Red	"PROTECTION" LED indicator
12	Negative	Speaker output connector
13	Positive	
14	-	Minimum speaker load allowed (impedance)

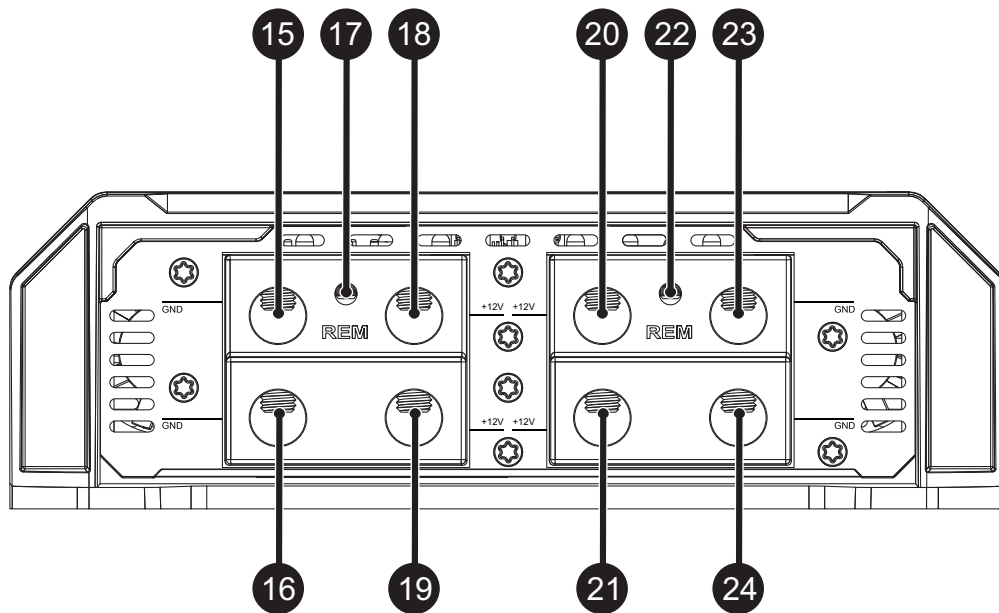

15	-	Negative power supply connector (GND)
16	-	Negative power supply connector (GND)
17	-	Remote power supply connector (REM)
18	-	Positive power supply connector (+12VDC)
19	-	Positive power supply connector (+12VDC)
20	-	Positive power supply connector (+12VDC)
21	-	Positive power supply connector (+12VDC)
22	-	Remote power supply connector (REM)
23	-	Negative power supply connector (GND)
24	-	Negative power supply connector (GND)

ELECTRICAL DIMENSIONING

For proper operation of your SoundDigital amplifier, you need the proper dimensioning of the electrical system and the cables used.

The table below shows the minimum section of GND cables, +12VDC cables and speaker output cables according to the power generated by the amplifier.

35000 WRMS	POWER CABLE (+12VDC)	90mm ² (000 AWG)
	GROUND CABLE (GND)	
	SPEAKER CABLE	2 x 21mm ² (4 AWG)

We recommend the use of only OFC (Oxygen Free Copper) cables on the installation of our products.

Copper-clad aluminum wire (CCAW) must not be used.

RCA INPUTS

Example of one RCA cable connection only.

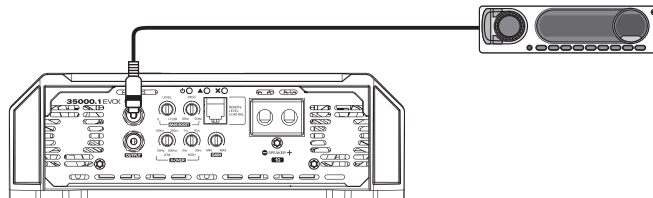

Example of two RCA cables connection (mono input).

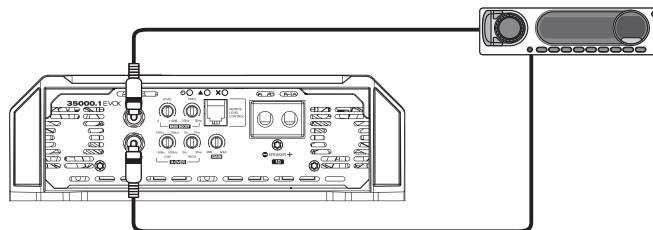

Example of one RCA cable connection only and using the RCA output to connect another amplifier.

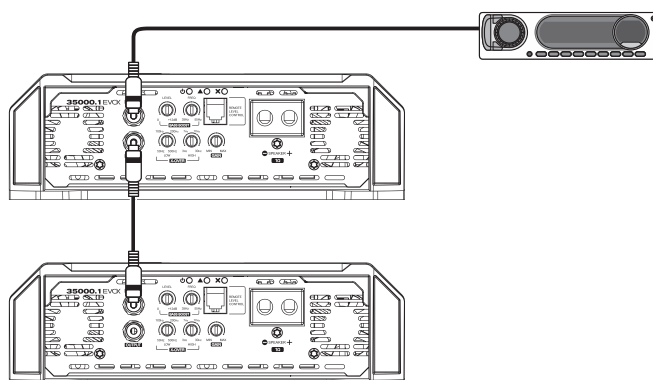

**Warning!**

BEFORE PROCEEDING WITH THE INSTALLATION, UNPLUG THE NEGATIVE TERMINAL FROM ALL OF THE BATTERIES, TO AVOID FIRE, DAMAGE TO THE AMPLIFIER AND THE USER HIMSELF.

- Mount the amplifier in such a way you have access to the connectors;
- Install the power cables in the vehicle properly, starting from the battery to the fuse holder or circuit breaker, use the cable with the appropriate size. Make all connections, install fuse holders or circuit breakers, but without placing the fuses or with the circuit breakers in the "OFF" position;

**Warning!**

THE MAXIMUM DISTANCE FOR THE INSTALLATION OF THE FUSE/CIRCUIT BREAKER IS 12 INCHES (30cm) AWAY FROM THE BATTERY.

- Connect the power cables in to the amplifier, observing the polarity. Connect all the positive cables (+) from the fuse holder or circuit breaker to the positive conector of the amplifier and all the negative power cables from the batteries to the negative connector of the amplifier;
- The ground cable must be as short as possible and must be connected to the vehicle chassis and the battery negative;

Remove the paint
between the terminal
and chassis

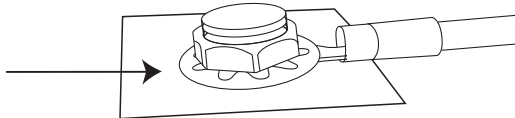

- Install the signal input cables in a proper way, distant from the power cables;
- Connect the RCA or the high level signal input cables to the head unit and amplifiers;
- Install the audio output cables with the appropriate section, distant from the power and audio input cables;
- Connect the audio output cables to the amplifier and speakers respecting the positive (+) and negative (-) polarities;
- Install the remote cable with the power cables, using 1.5mm² (15 AWG) cable or thicker;
- Connect the remote power cable to the amplifier's "REM" terminal at the main unit's remote power output (when not using the high level signal inputs);
- Before powering the system, verify all the connections and make sure there are no mistakes or short-circuits on the power and ground cables;
- Reconnect the ground of the batteries;
- Check if the head unit is turned off and then place the fuses in the fuse holders or switch the circuit breakers on;
- Turn on the main unit and the amplifier will turn on the "POWER ON" LED indicating that it is in operation.

**Warning!**

Minimum recommended
installation distance
between amplifiers*.
1.18in (30mm)

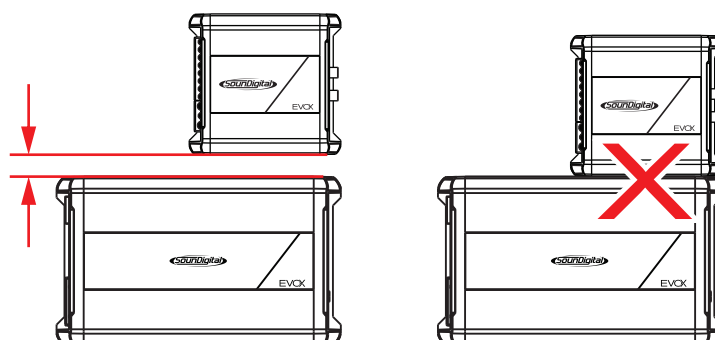

*For installations with more than one amplifier, second unit not included. Merely illustrative images.

EXTERNAL LEVEL CONTROL - SD RLC (*Not included)

The SD RLC is an easy-to-install external level control accessory that allows you to tune the level of SOUNDIGITAL amplifiers that have remote level control.

In SD RLC, you can adjust the amplifier level without having to lean over and adjust the gain setting on the amplifier and can monitor the "CLIP" LED which is also available on the accessory.

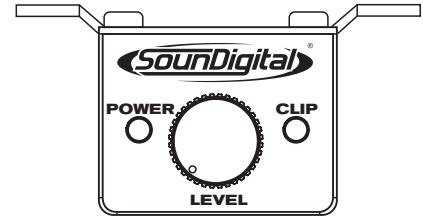

SD REMOTE
LEVEL CONTROL*

*Sold separately

GAIN SETTING

Necessary equipment:

- Digital AC voltmeter;
- Media with sine wave test tone 60Hz recorded at 0db;
- Screwdriver 1/8" (for gain setting).
- Set the audio player fader control to center position (left and right fader controls);
- Set the variable "LOW" crossover in 500Hz and the "HIGH" in 3Hz;

Set up procedure:

- Turn the gain control all the way down;
- Disconnect the output cables from the amplifier outputs;
- Turn off all processing (bass, treble, loudness, EQ, etc.);
- Set the audio player volume to 3/4 of full volume;
- Use a 60 Hz sine wave;
- Increase the gain control until the "CLIP" LED starts blinking;
- Return the gain to the limit where the "CLIP" LED stops blinking and remains off;
- Once you have adjusted the amplifier to the correct voltage output, turn off the source unit and reconnect the speaker(s).

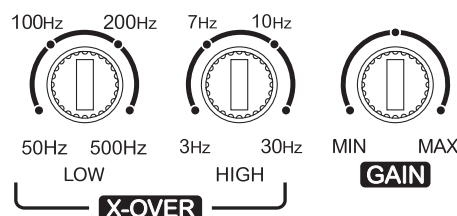

Download the tracks for set up in <https://soundigitalusa.com/tracks-for-set-up/>

Using Bass Boost

The Amplifier Bass Boost setting enables the user to boost the sound intensity at low frequencies of the sound system, where boost intensity can be adjusted, as well as the frequency of the region to be boosted, as indicated in the chart . This is a semi-parametric equalizer type circuit with "Q" value for the fixed filter, with an intensity boost adjustment from 0 to + 12dB (16 times), and a central frequency adjustment of the filter between 35 and 55Hz, making it versatile for several types of sound systems.

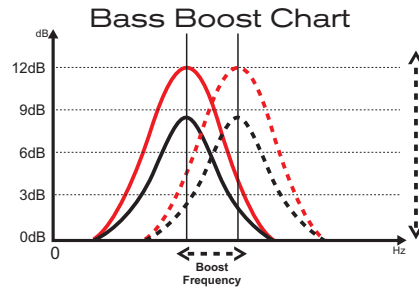

How to Adjust Bass Boost

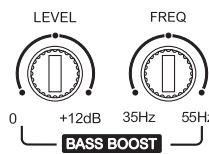

Reproduce your favorite song and set the variable frequency control to the frequency you want boost between 35Hz and 55Hz. Set boost intensity between 0dB and +12dB at the variable control Level.

How to Adjust the Crossovers

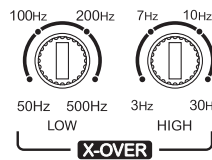

Set in the "HIGH" variable control between 3Hz and 30Hz ("A") where you want to perform the high pass cut filter;

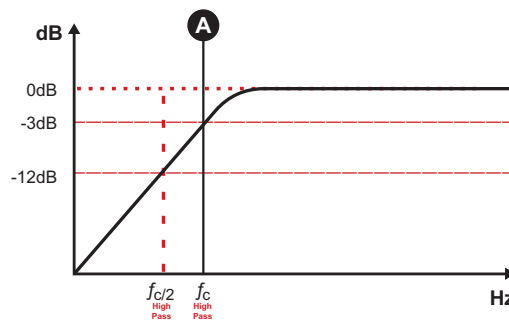

Set in the "LOW" variable control between 50Hz and 500Hz ("B") where you want to perform the low pass cut filter;

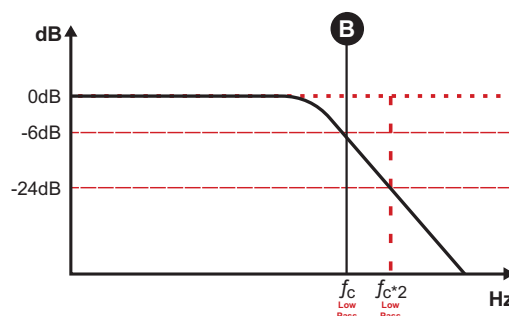



Unplug the negative (-) terminal of the battery before proceeding with any electrical installation in the vehicle to avoid fire starts, wounds or damage to the amplifier.

POWER CONNECTIONS

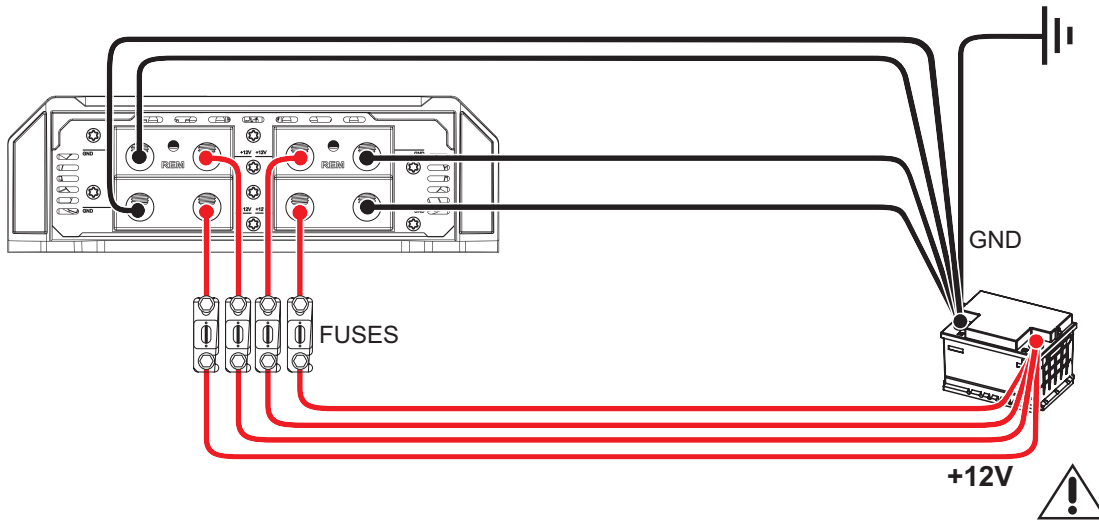

In case of connections with more than one battery, see the installation diagram on page 15.

REMOTE INPUT CONNECTIONS

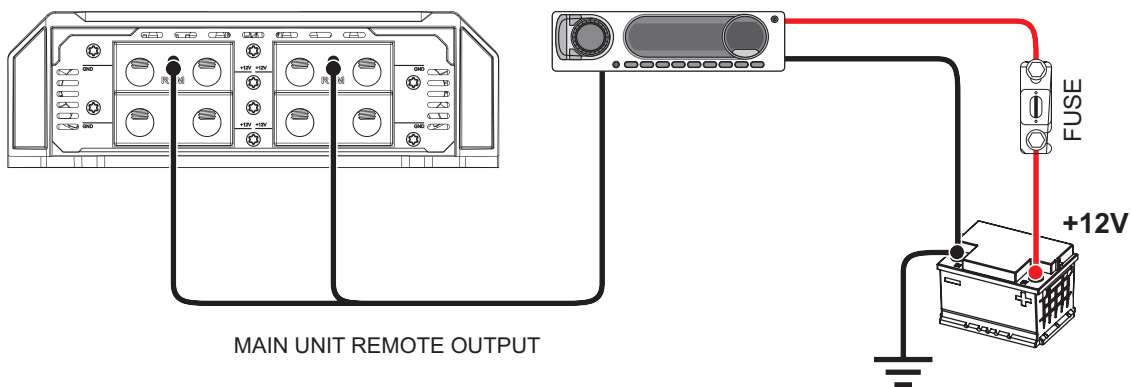

AUDIO INPUT AND OUTPUT CONNECTIONS

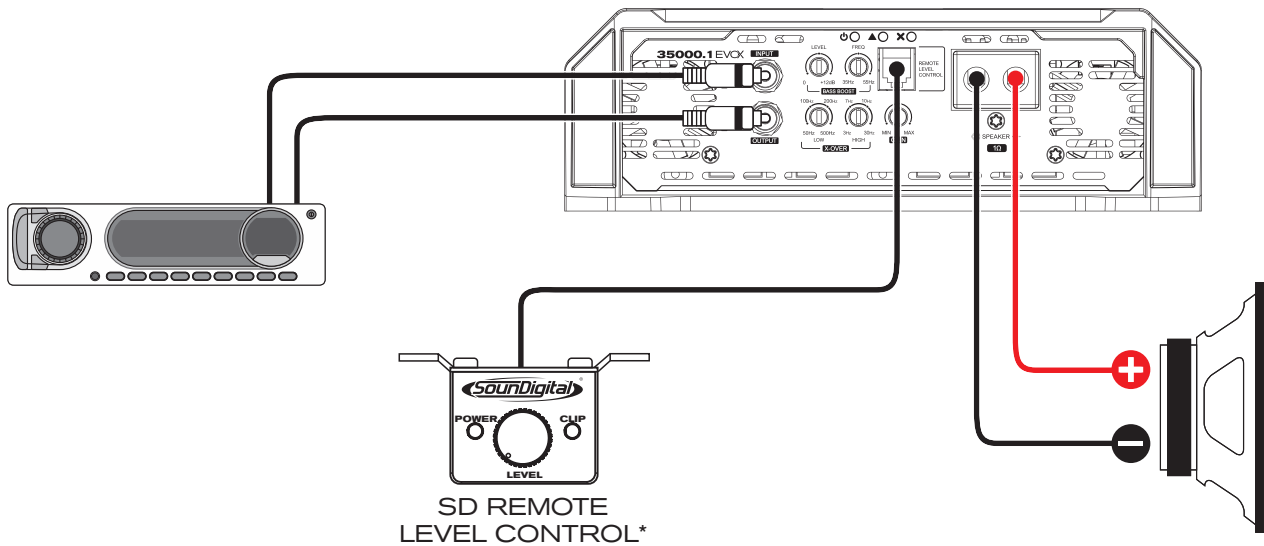

SD REMOTE LEVEL CONTROL*

*Sold separately

When necessary the association of one or more battery banks to supply the necessary current to the amplifier, it is recommended to use batteries of the same brand, model, and if possible the same manufacturing lot so that the system has the maximum performance.

For an ideal energy performance, we recommend that all batteries be connected to positive and negative busbars and the busbars connected to the amplifier, as shown in the diagram below:

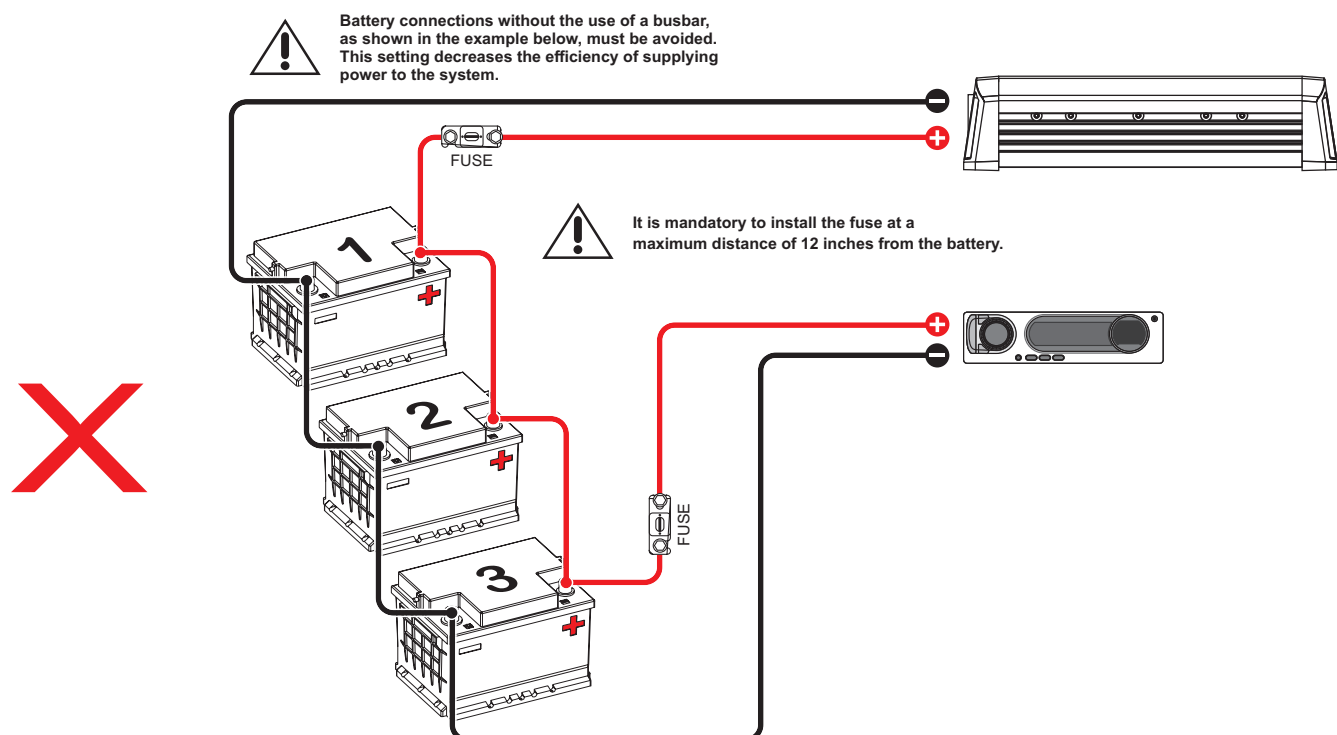
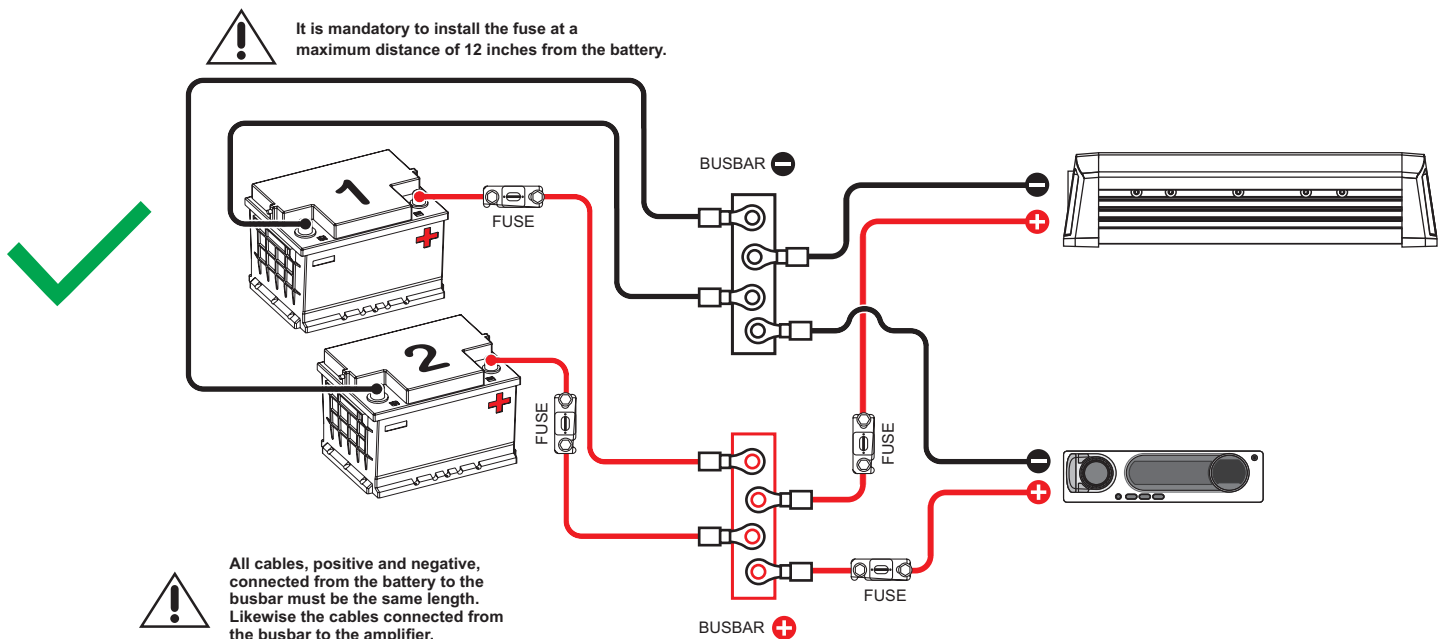

PARAMETERS	35000.1EV0X 1Ω
RMS Power @ 4Ω**	1 x 15246W
RMS Power @ 2Ω**	1 x 23100W
RMS Power @ 1Ω**	1 x 35000W
Frequency Response (-3dB)	3Hz ~ 500Hz
High Pass Filter (12dB/octave)	3Hz ~ 30Hz
Low Pass Filter (12dB/octave)	50Hz ~ 500Hz
Bass Boost Level	0dB ~ +12dB
Bass Boost Frequency	35Hz ~ 55Hz
Operating Voltage	9V ~ 16V
SNR	76dB
Input Sensitivity (RCA)	0.8 ~ 4V
Current Draw (music)	N/A
Current Draw (max.)	3429A
Total Efficiency	81%
Damping Factor (@100Hz nominal impedance)	200
Power Cable	90mm ² (000 AWG)
Speaker Cable	2 x 21mm ² (4 AWG)
Remote Cable	1.5mm ² (15 AWG)
Recommended Fuse* (music)	3500A
Recommended Battery (minimum)	3500Ah

*It is mandatory to install the fuse at a maximum distance of 12 inches from the battery.

**Power at 14.4V @ 60Hz with a maximum THD of 1%.



**POWER RATING ACCORDING TO CTA-2006 INDUSTRY STANDARDS.

DIMENSIONAL DATA

Net Weight
12.57 kg (27.71 lb)

Gross Weight
14.64 kg (32.27 lb)

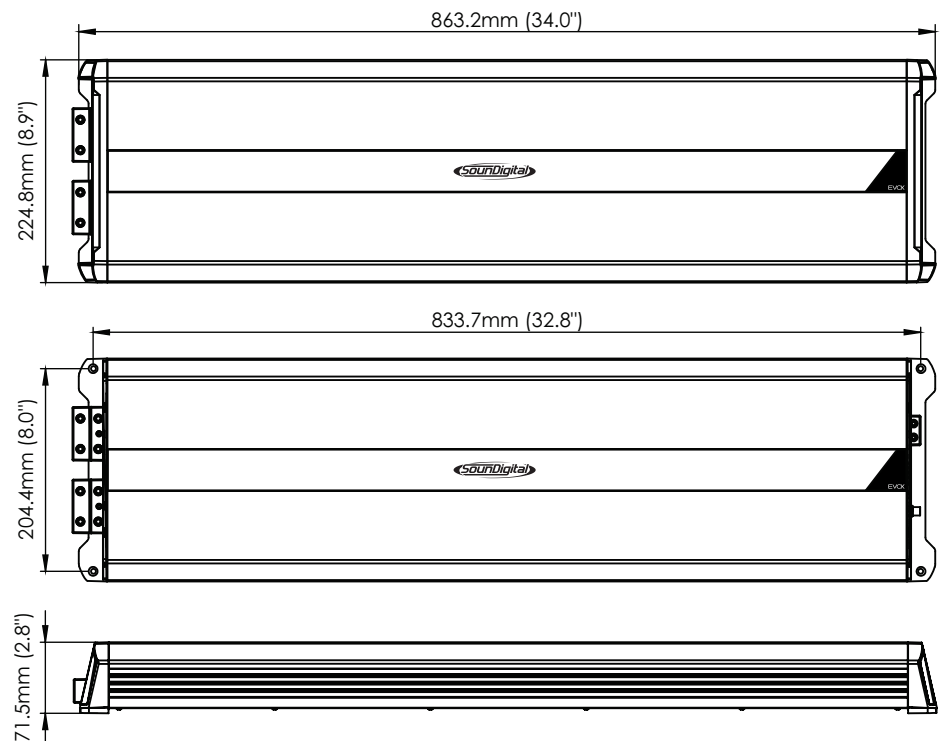

ADDITIONAL INFORMATION

The values presented are based on measurements performed in SounDigital's laboratories. All the equipment used in the assays, tests, measurements and gauging of the technical parameters of SounDigital products were calibrated in certified laboratories, thus ensuring the performance and standard of excellence of the developed products.

The Manufacturing Process may present variations, and the electronic components may also present changes in values in relation to their nominal parameters. Thus, causing small differences between measurements taken. Small variations in the values presented and divulged by SounDigital are recognized.



Updates of information made in this document will always be published and made available for consumer consultation, free of charge, on the brand's websites. The user is advised to search for the manual in its latest version when necessary.

The images presented in this document are representative and merely illustrative; therefore, they do not necessarily correspond to the actual product/model.



YOUR MUSIC. **YOUR POWER.**

Document revision code: 1000750352-003/NOV2023



Consumer
Technology
Association™



WWW.SOUNDIGITALUSA.COM



[SOUNDIGITALUSA](https://www.facebook.com/SOUNDIGITALUSA)



[SOUNDIGITALUSA](https://www.instagram.com/SOUNDIGITALUSA)